

## Quick-Start Kit: 18ft Straight Floor Mount

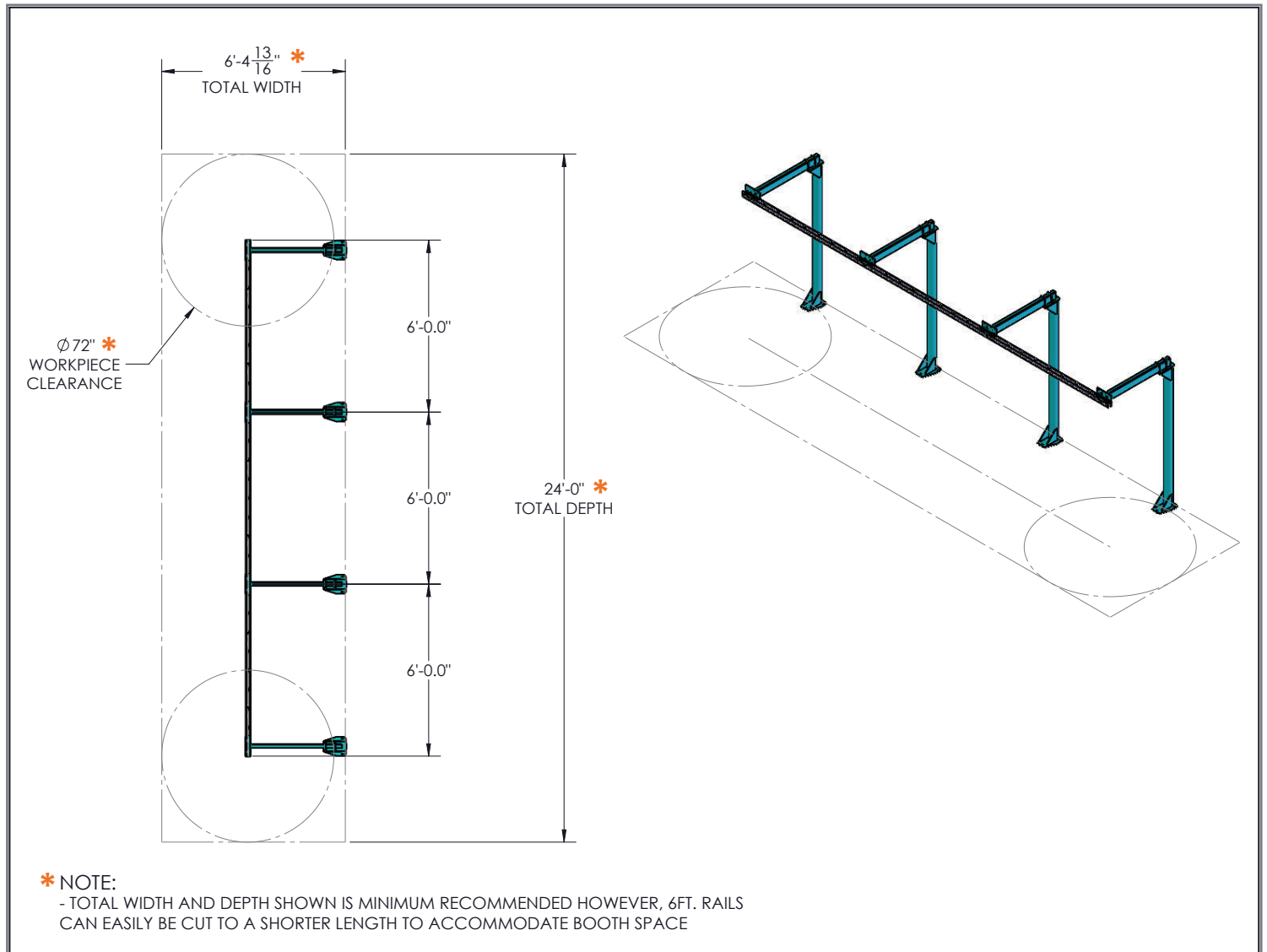







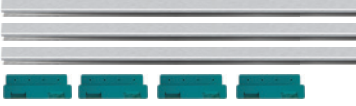

Allows 40 parts to be processed at a time



**The PivotLine System can be configured to fit any shop size and budget.** Our quick-start kits cover some of our most popular use cases, and as your shop's volume increases, the system can easily be expanded or reconfigured.

**18ft Straight Kit:** Allows for smooth back-and-forth movement of parts along the rail.

A complete list of the included components and pricing is on the following page.

Description	Qty	Rate	Amt
<b>PivotLine Stationary Rail Kit 18ft. Straight Complete</b> 3 - Aluminum rail - 6 ft. length * 4 - Rail Support / Joiner 	1	\$1,392.00	\$1,392.00
<b>Rolling Spray Hub</b> Rolls smoothly and pivots in 90° increments allowing for easy spraying of all sides 	20	\$84.00	\$1,680.00
<b>Twist Stop</b> Insert into stationary and mobile rails to prevent unwanted movement of materials 	2	\$89.00	\$178.00
<b>T-Bar - Short (17")</b> Hang doors using EFC or Offset Hangers. Group multiple parts together by hanging Offset and Universal Hangers across top of T-Bars 	6	\$25.00	\$150.00
<b>T-Bar - Medium (34")</b> Hang doors using EFC or Offset Hangers. Group multiple parts together by hanging Offset and Universal Hangers across top of T-Bars 	8	\$42.00	\$336.00
<b>T-Bar - Large (46")</b> Hang doors using EFC or Offset Hangers. Group multiple parts together by hanging Offset and Universal Hangers across top of T-Bars 	6	\$56.00	\$336.00
<b>Offset Hanger w/screws</b> For hanging drawer fronts, face frames, and other miscellaneous components 	20	\$11.20	\$224.00
<b>Universal Hanger w/screws</b> For hanging shelves, face frames, and other miscellaneous components 	10	\$11.20	\$112.00
<b>EFC (Spring Clip)</b> For hanging panels from hinge pockets to hang on T-Bars 	60	\$1.50	\$90.00
<b>Floor Stand - Comes with 1 of 3 optional stand-off arm sizes</b> Stand-off arm size determines the clearance and size of materials that can be rotated without making contact: <b>Small</b> (48" max material width), <b>Medium</b> (72" max material width), <b>Large</b> (48" max material width) * 	4	\$615.00	\$2,460.00

\* 6ft. rails can easily be cut to shorter length if needed

\* Stand-off arm size must be specified before order can be processed

Subtotal	\$6,958.00
Shipping & handling	\$0.00
Discount	\$0.00
Tax	\$0.00
<b>Total</b>	<b>\$6,958.00</b>